

# Sensors & Applications Additive Manufacturing / 3D Printing

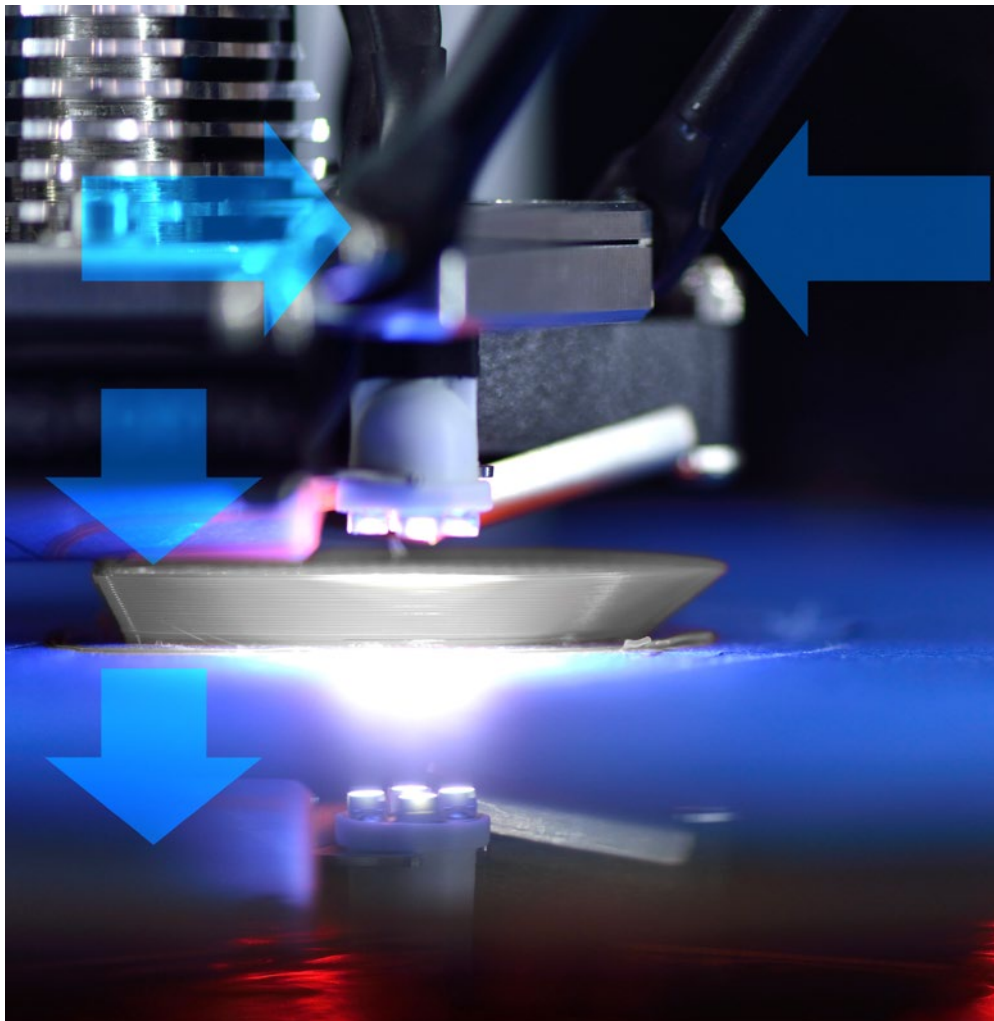

More Precision

# High-precision position monitoring

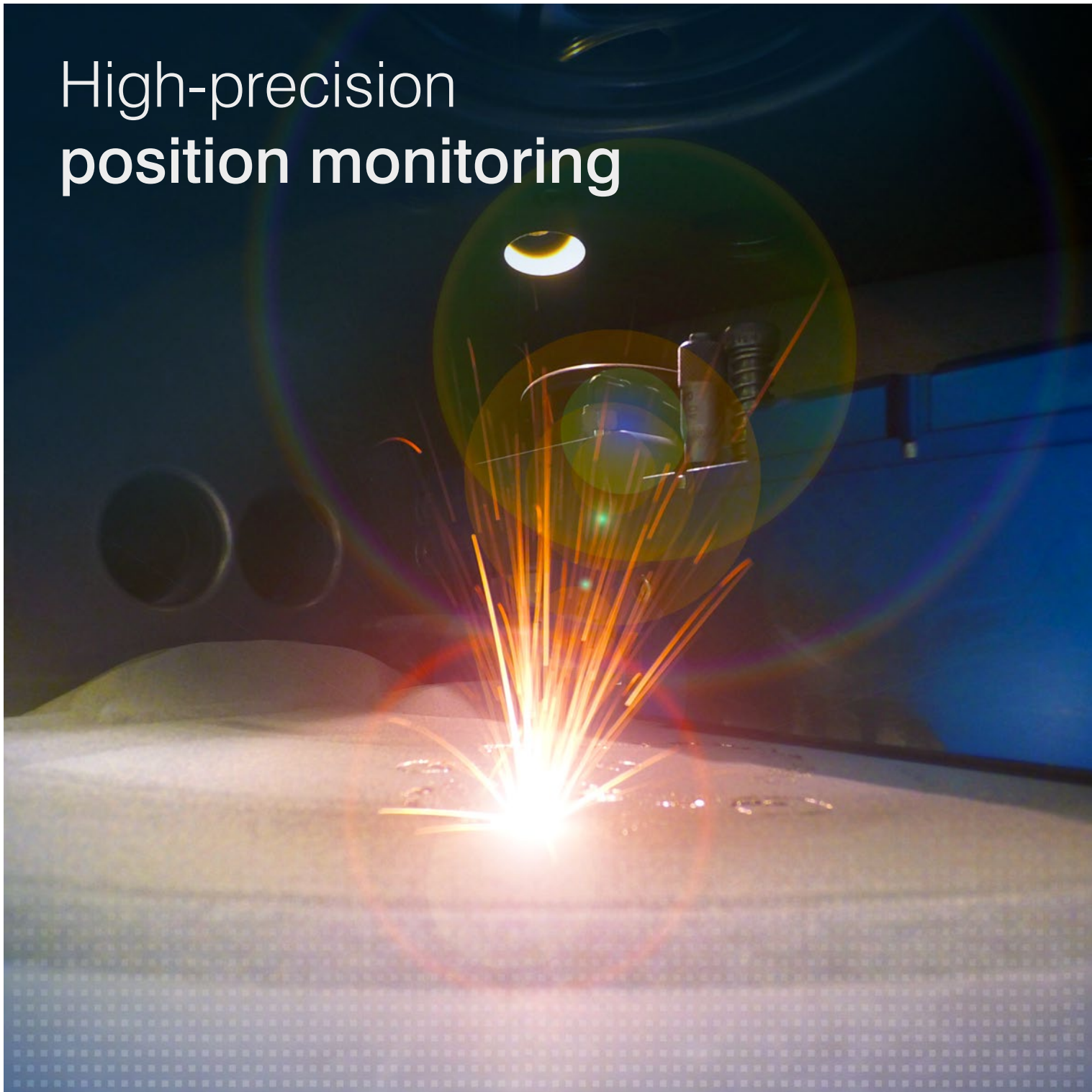



### Monitoring the tilted squeegee

Capacitive sensors monitor the position of the squeegee. Two synchronized sensors measure with high resolution both ends of the squeegee to provide exact statements about its tilt angle. This is to ensure that the powder bed has been pulled off evenly.

Sensor: *capaNCDT 6200*



### capaNCDT 6200

- Capacitive multi-channel measuring system for machine position monitoring
- Displacement and distance measurements down to the nanometer with measuring ranges from 0.05 to 10 mm
- High frequency response for dynamic measurements
- Ideal for long-term stable measurements
- Multi-channel controller for synchronous detection of multiple measuring positions



### eddyNCDT 3005

- Miniature eddy current measuring system, ideal for integration into plant and machinery
- Non-contact displacement and distance measurements with measuring ranges from 1 to 6 mm
- High accuracy and high frequency response
- Pressure-resistant versions up to 2000 bar, resistant to oil, dust & dirt



### Orientation and positioning of the building platform

With selective laser sintering, the building platform is lowered after each melting cycle by a defined value which corresponds to the required Z resolution. Inductive displacement sensors based on eddy currents monitor this building platform in order to allow the print head to be aligned in parallel.

Sensor: *eddyNCDT 3005*



# Position monitoring of printing processes

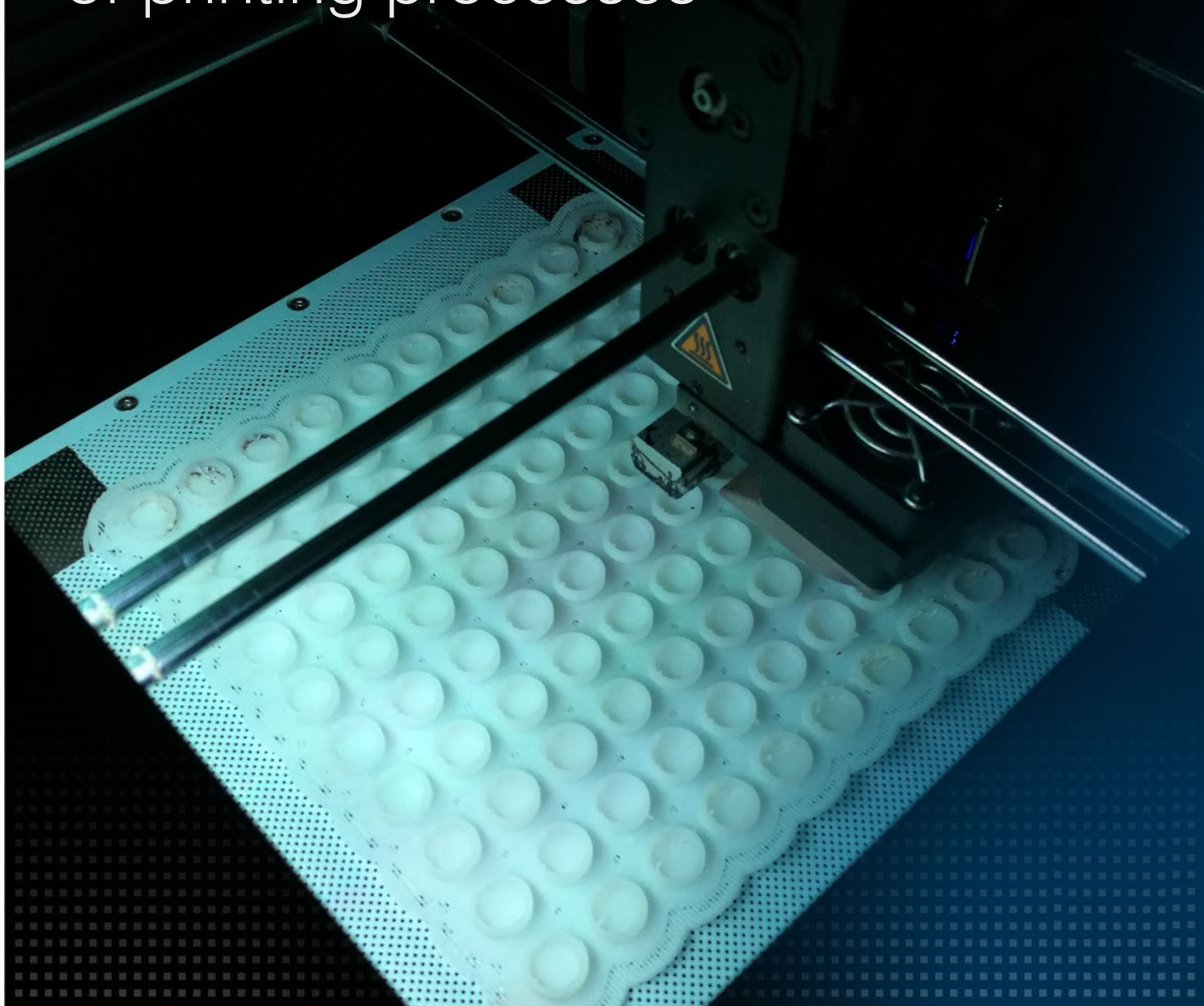

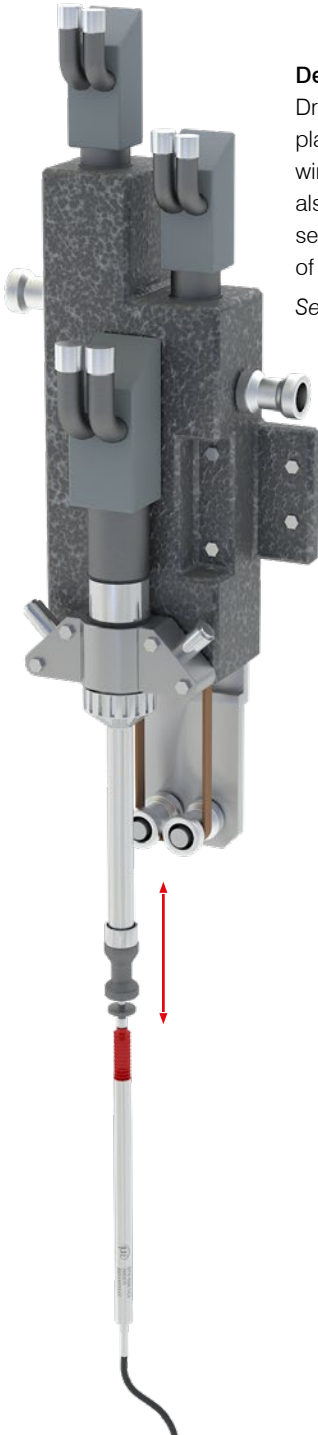

### Detection of platform tilt and position

Draw-wire displacement sensors are used to continuously check the tilting of girder platforms. The sensors are mounted outside the pressure chamber. The measuring wire is guided into the pressure chamber via deflection pulleys. Therefore, this design is also suitable for environments with high temperatures and dust formation. The compact sensors have large measuring ranges and can therefore detect the tilt even if the position of the platform varies.

*Sensor: wireSENSOR MK*



### Print-head calibration in Z-axis direction

To obtain repeatable print results, the Z-axis position of print heads is calibrated fully automatically. For this purpose, the print head moves to a defined position and lowers in the Z-axis direction. An induSENSOR DTA gauge detects the Z-axis movement at high accuracy. The determined distance data is taught-in for regular calibration of the Z-axis position of the print head.

*Sensor: induSENSOR DTA*



# Monitoring of printing processes

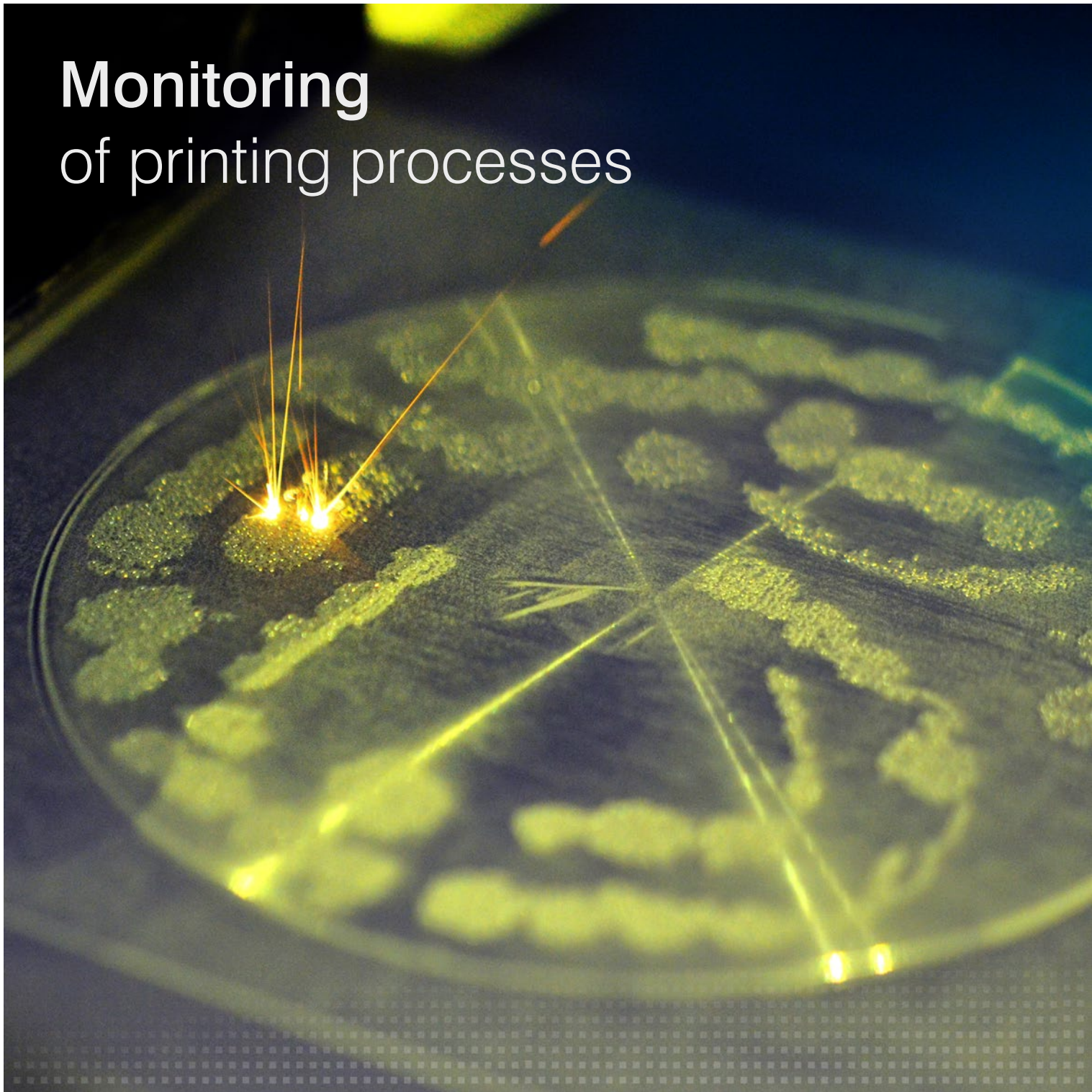

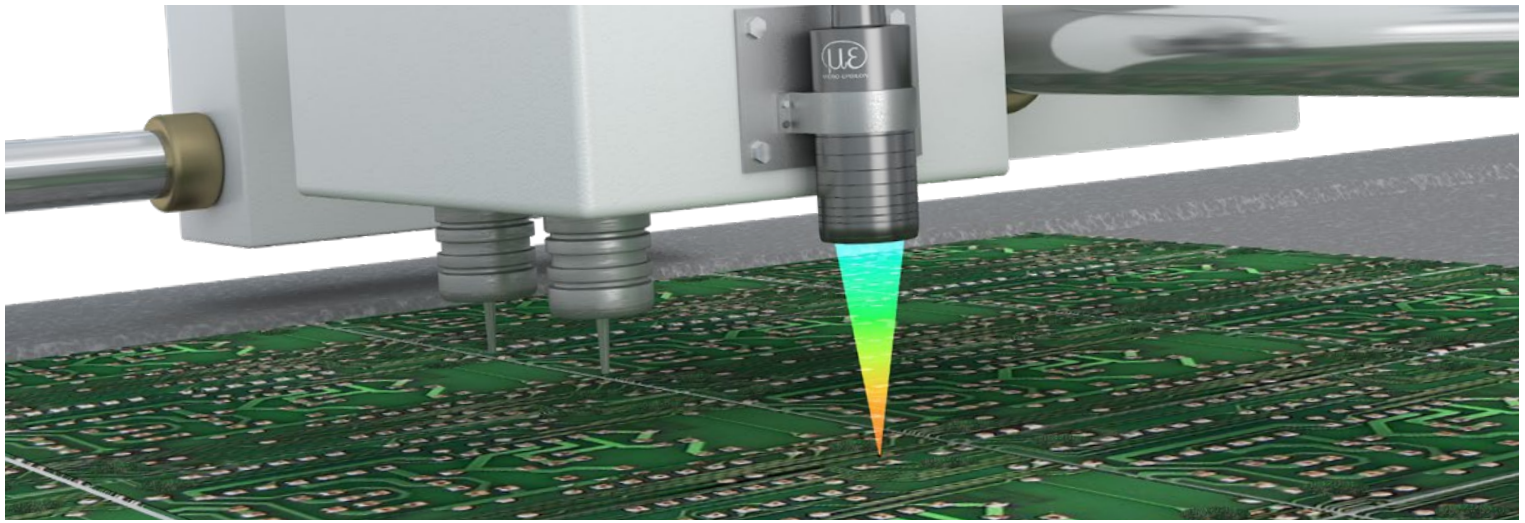

### High-precision sensors for print head tracking

Precise positioning of the print head is particularly necessary for 3D printing of complex components as well as for PCB printing. Confocal sensors are used to check positioning with submicrometer accuracy. These detect the distance with the highest precision and high measuring rate. This also allows dynamic pressure processes to be controlled.

*Sensor: confocalDT*



### Temperature measurement of the powder bed and the carrier platform

In certain 3D printing processes, the powder bed is heated to ensure defined processing temperatures. Miniature thermoMETER UC pyrometers are used to monitor the temperatures. These are mounted on the top and detect the temperature regardless of how far away the powder bed is. The sensors measure with high reliability even at high ambient temperatures in the installation space.

*Sensor: thermoMETER UC*



# Distance control of the print head

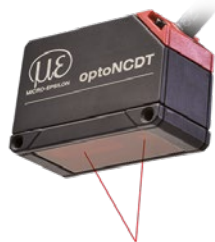

## **optoNCDT 1420**

- Powerful laser displacement sensor for print head control
- Measuring rate of 8 kHz for precise and high speed measurements
- Measuring ranges: 10 mm - 500 mm
- Compact sensor design with integrated controller
- Robust and long-life design



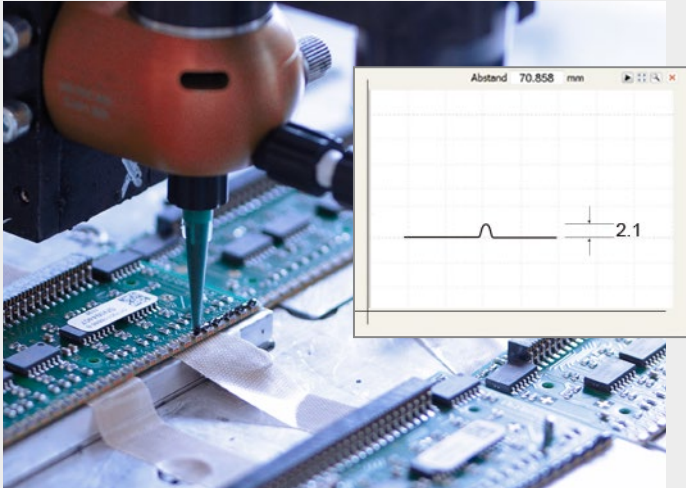

### Glue bead measurement in dispensing systems

After the reflow soldering process, glue is applied on some points to protect the circuit. The glue bead thickness is a critical factor that is reliably inspected using laser sensors.

*Sensor: optoNCDT 1420*

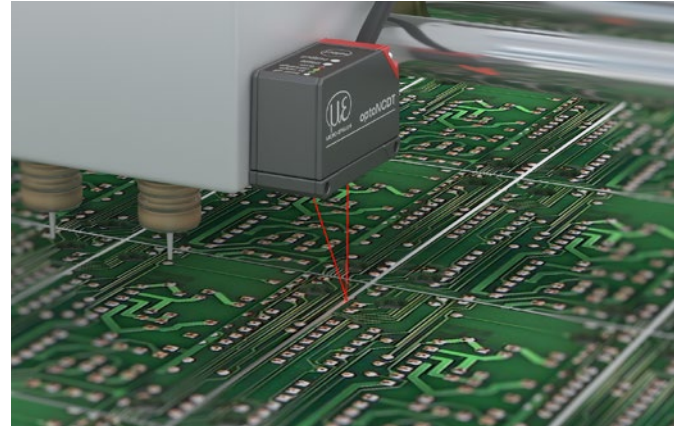

### High-resolution fine positioning when printing PCBs

With printing, soldering and assembly processes of printed circuit boards, the exact height positioning of the print head is crucial for a flawless process. optoNCDT laser sensors enable precise positioning of the print head. Regardless of surface reflections, these sensors provide precise measurement results which are used to adjust the height and to detect the edges.

*Sensor: optoNCDT 1420*

### Print head positioning and focal point control

With printing processes, the exact height of the print head is a crucial factor for the quality of the final product. High-speed distance measurement against different material surfaces and reliable edge detection enable a fast readjustment process.

*Sensor: optoNCDT 1420*



# Inline quality monitoring

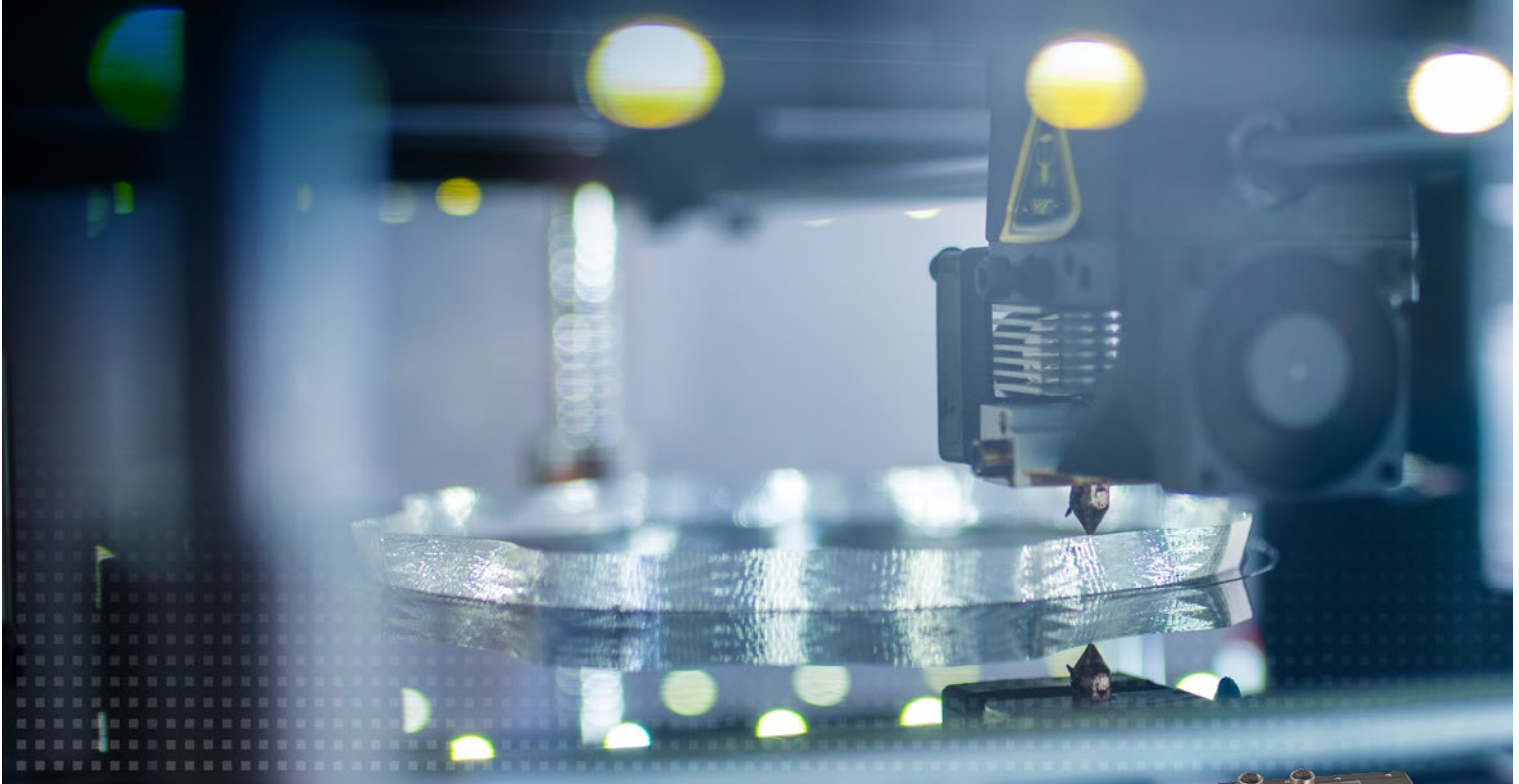

## scanCONTROL

- Compact laser scanner with integrated controller
- High profile frequency for dynamic measurements
- Synchronization enables multi-scanner applications
- Various measuring ranges
- Blue Laser Technology for high precision with various surfaces

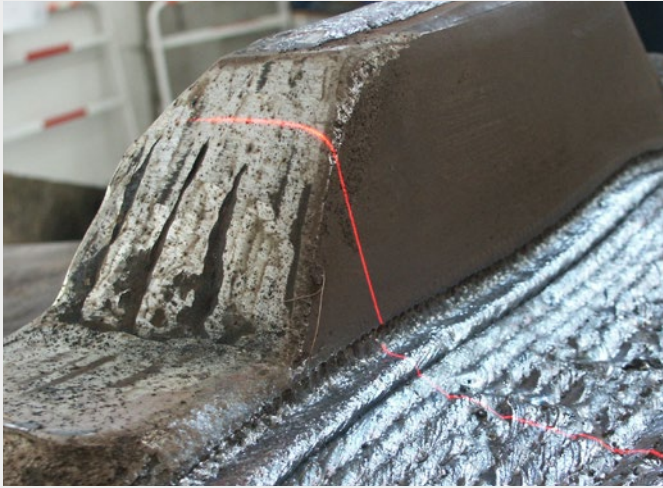

### Robot path calculation in repair welding processes

In order to calculate the robot path, scanCONTROL laser scanners determine the areas that need to be welded. Providing a high profile resolution and profile frequency, these laser scanners enable quick repairs.

*Sensor: scanCONTROL 3060*

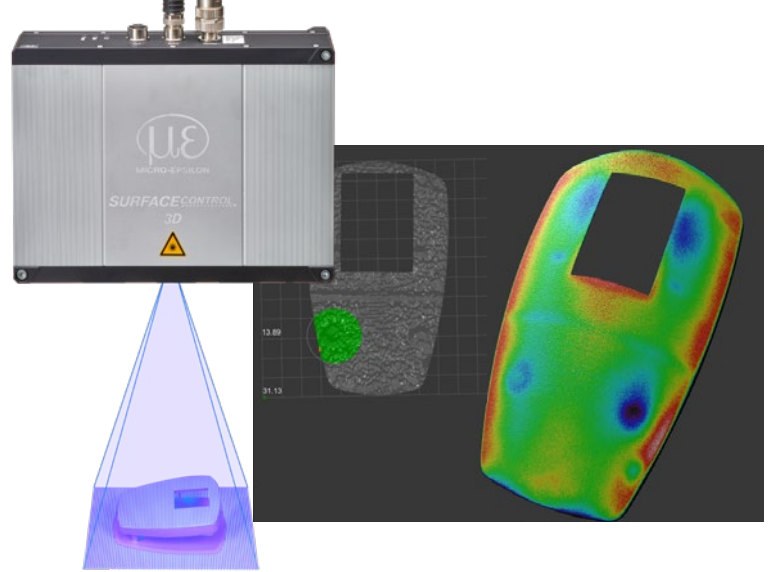

### High-precision 3D measurement in final inspection

To check the dimensional accuracy of printed components, surfaceCONTROL 3D sensors are used. These generate high-resolution snapshots of the components in a very short timeframe. The powerful 3DInspect software evaluates and outputs the point clouds.

*Sensor: surfaceCONTROL 3D*



### 3D scan before laser cladding

Laser scanners from Micro-Epsilon are used to detect the contour during laser cladding. These scanners detect the exact contour of the object before the weld is deposited. The 3D data is used to exactly determine the guidance of the weld head.

*Sensor: scanCONTROL 2900*

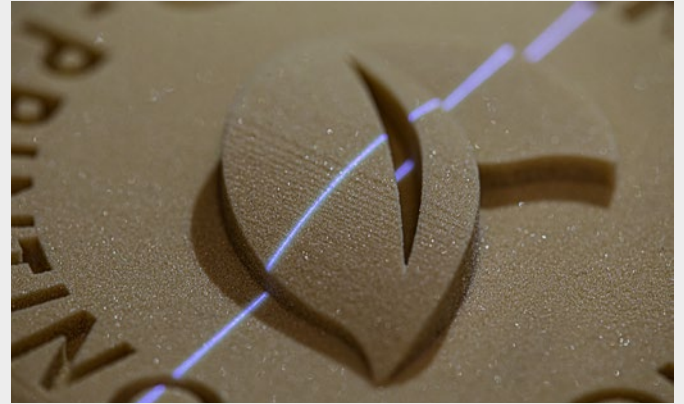

### CAD comparison of the printed component

In order to monitor their production quality, printed components are inspected using Blue Laser scanners. The components are moved past the scanners with a traversing unit. A 3D image is produced from the laser profiles and then compared with the CAD data.

*Sensor: scanCONTROL 3060BL*



## Sensors and Systems from Micro-Epsilon



Sensors and systems for displacement, distance and position



Sensors and measurement devices for non-contact temperature measurement



Measuring and inspection systems for metal strips, plastics and rubber



Optical micrometers and fiber optics, measuring and test amplifiers



Color recognition sensors, LED analyzers and inline color spectrometers

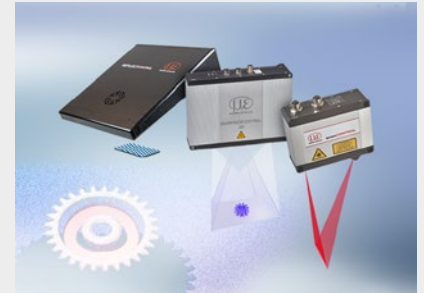

3D measurement technology for dimensional testing and surface inspection

## More Precision

Whether it is for quality assurance, predictive maintenance, process and machine monitoring, automation or R&D – sensors from Micro-Epsilon make a vital contribution to the improvement of products and processes. High precision sensors and measuring systems solve measurement tasks in all core industries – from machine building to automated production lines and integrated OEM solutions.



[www.micro-epsilon.com](http://www.micro-epsilon.com)