









More Precision

confocalDT // Confocal chromatic sensor system



High precision sensors for displacement and thickness measurements confocalDT IFS2407

-  Compact sensors from $\varnothing 12$ mm
-  Submicron resolution
-  For one-sided thickness measurements
-  Suitable for precise distance measurements
-  Very small light spot
-  Large tilt angle

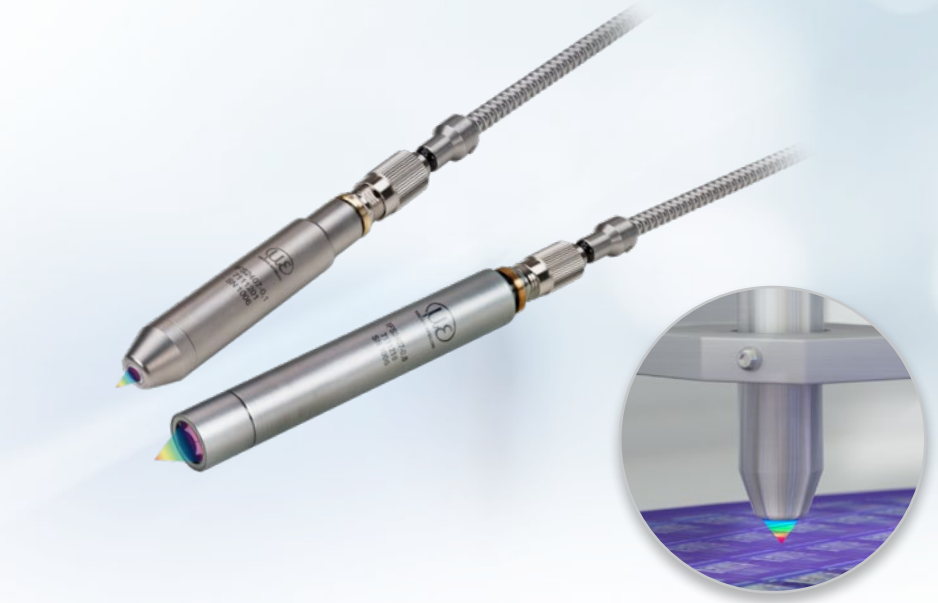

Model		IFS2407-0.1	IFS2407-0.1(001)	IFS2407-0.8
Measuring range		0.1 mm	0.1 mm	0.8 mm
Start of measuring range	approx.	1 mm	1 mm	5.9 mm
Resolution	Static ^[1]	< 1 nm	< 1 nm	< 9 nm
	Dynamic ^[2]	< 6 nm	< 6 nm	< 75 nm
Linearity ^[3]	Displacement and distance	< $\pm 0.04 \mu\text{m}$	< $\pm 0.04 \mu\text{m}$	< $\pm 0.2 \mu\text{m}$
	Thickness	-	-	< $\pm 0.4 \mu\text{m}$
Light spot diameter		3 μm	4 μm	6 μm
Maximum measuring angle ^[4]		$\pm 48^\circ$	$\pm 48^\circ$	$\pm 30^\circ$
Numerical aperture (NA)		0.80	0.70	0.50
Min. target thickness ^[5]		0.005 mm	0.005 mm	0.04 mm
Target material		reflective, diffuse as well as transparent surfaces (e.g. glass)		
Connection		pluggable optical fiber via FC socket; for cable type and cable length, see accessories		
Mounting		Radial clamping (mounting adapter see accessories)		
Temperature range	Storage	-20 °C ... +70 °C		
	Operation	+5 °C ... +70 °C		
Shock (DIN EN 60068-2-27)		15 g / 6 ms in XY axis, 1000 shocks each		
Vibration (DIN EN 60068-2-6)		2 g/ 20 ... 500 Hz in XY axis, 10 cycles each		
Protection class (DIN EN 60529)		IP65 (front)		
Material		Stainless steel housing, glass lenses		
Weight ^[6]		approx. 36 g	approx. 36 g	approx. 40 g
Special features		Sensor with high numerical aperture	Light-intensive sensor	-

^[1] Average from 2,048 values at 1 kHz, in the mid of the measuring range onto optical flat

^[2] RMS noise relates to mid of measuring range (1 kHz)

^[3] All data at constant ambient temperature (25 \pm 1 °C). Measurement on plane-parallel test glass. Acceptance report is enclosed with delivery

^[4] Maximum sensor measuring angle up to which a usable signal can be achieved on reflective surfaces, with accuracy decreasing toward the limit values

^[5] Glass sheet with refractive index n = 1.5 throughout the entire measuring range. In the mid of the measuring range, also thinner layers can be measured.

^[6] Sensor weight without optical fiber

Dimensions
(in mm, not to scale)

IFS2407-0.1
IFS2407-0.1(001)

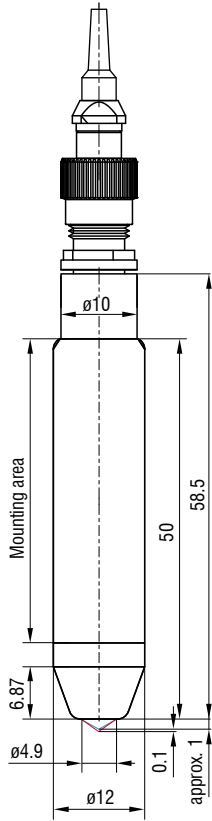



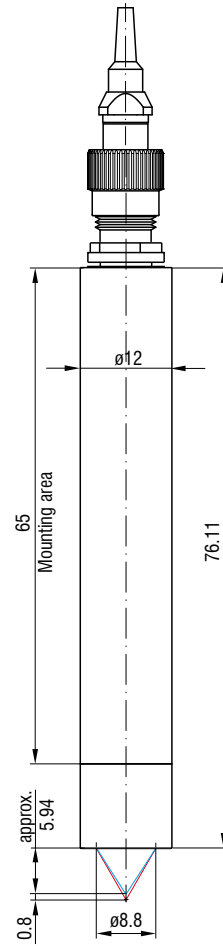



IFS2407-0.8



High precision sensors for displacement and thickness measurements

confocalDT IFS2407

-  Compact sensors from $\varnothing 12$ mm
-  Submicron resolution
-  For one-sided thickness measurements
-  Suitable for precise distance measurements
-  Very small light spot
-  Large tilt angle



Model		IFS2407/90-0.3	IFS2407-1.5	IFS2407-3	IFS2407-6
Measuring range		0.3 mm	1.5 mm	3 mm	6 mm
Start of measuring range	approx.	5.3 mm	17 mm	28 mm	32 mm
Resolution	Static ^[1]	< 3 nm	< 3 nm	< 7 nm	< 8 nm
	Dynamic ^[2]	< 20 nm	< 36 nm	< 63 nm	< 90 nm
Linearity ^[3]	Displacement and distance	< $\pm 0.10 \mu\text{m}$	< $\pm 0.16 \mu\text{m}$	< $\pm 0.45 \mu\text{m}$	$\leq \pm 0.9 \mu\text{m}$
	Thickness	< $\pm 0.20 \mu\text{m}$	< $\pm 0.4 \mu\text{m}$	< $\pm 0.9 \mu\text{m}$	$\leq \pm 1.8 \mu\text{m}$
Light spot diameter		6 μm	5.5 μm	9 μm	14 μm
Maximum measuring angle ^[4]		$\pm 27^\circ$	$\pm 43^\circ (\pm 70^\circ)$ ^[5]	$\pm 30^\circ$	$\pm 23^\circ$
Numerical aperture (NA)		0.50	0.70	0.53	0.45
Min. target thickness ^[6]		0.015 mm	0.075 mm	0.15 mm	0.3 mm
Target material		reflective, diffuse as well as transparent surfaces (e.g. glass)			
Connection		pluggable optical fiber via FC socket; for cable type and cable length, see accessories			
Mounting		Mounting holes (2x M2)	Radial clamping (mounting adapter see accessories)		
Temperature range	Storage	-20 °C... +70 °C			
	Operation	+5 °C... +70 °C			
Shock (DIN EN 60068-2-27)		15 g / 6 ms in XY axis, 1000 shocks each			
Vibration (DIN EN 60068-2-6)		2 g / 20 ... 500 Hz in XY axis, 10 cycles each			
Protection class (DIN EN 60529)		IP65 (front)			
Material		Stainless steel housing, glass lenses		Aluminum housing, glass lenses	
Weight ^[7]		approx. 30 g	approx. 800 g	approx. 550 g	approx. 350 g

^[1] Average from 2,048 values at 1 kHz, in the mid of the measuring range onto optical flat

^[2] RMS noise relates to mid of measuring range (1 kHz)

^[3] All data at constant ambient temperature (25 ± 1 °C). Measurement on plane-parallel test glass. Acceptance report is enclosed with delivery

^[4] Maximum sensor measuring angle up to which a usable signal can be achieved on reflective surfaces, with accuracy decreasing toward the limit values

^[5] Maximum sensor measuring angle up to which a usable signal can be achieved on diffusely reflecting metallic surfaces, with accuracy decreasing toward the limit values

^[6] Glass sheet with refractive index $n = 1.5$ throughout the entire measuring range. In the mid of the measuring range, also thinner layers can be measured.

^[7] Sensor weight without optical fiber

Accessories

Optical fiber and vacuum feedthrough

All Micro-Epsilon confocal controllers are compatible with any IFS240x sensor.

The IFS2402 and IFS2403 sensors already have integrated optical fibers

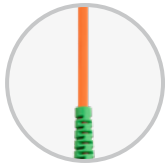

Standard fiber optics

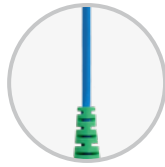

Fiber optics suitable for drag chains



Protective hose for mechanical stress



Robot-compatible fiber optics



Vacuum / UHV version HT version

Sensor-specific optical fiber ¹⁾		IFS2404 Measuring ranges 2/4	IFS2404 Measuring ranges 1/3/6/18	IFS2405	IFS2406	IFS2407	IFS2407-HT
C2404-x	with FC/APC and E2000/APC connectors; fiber core diameter 20 μm (0.3 m, 2 m, 3 m, 5 m, custom lengths up to 50 m)	✓ ²⁾	⊘	⊘	⊘	⊘	⊘
C2401-x	with FC/APC and E2000/APC connectors (3 m, 5 m, 10 m, customer-specific length up to 50 m)						
Other versions:							
C2401/PT3-x	Optical fiber with protective hose for mechanical stress (3 m, 5 m, 10 m, customer-specific length up to 50 m)	⊘	✓	✓	✓	✓	⊘
C2401-x(01)	Optical fiber core diameter 26 μm (3 m, 5 m, 15 m)						
C2401-x(10)	Drag-chain suitable optical fiber (3 m, 5 m, 10 m)						
C2401-x(20)	Robot-suitable optical fiber (3 m, 5 m, 10 m)						
C2400-x	2x FC/APC connectors (3 m, 5 m, 10 m, customer-specific length up to 50 m) ⁵⁾						
Other versions:							
C2400/PT-x	Optical fiber with protective hose for mechanical stress (3 m, 5 m, 10 m, customer-specific length up to 50 m) ⁵⁾	⊘	✓	✓	✓	✓	⊘
C2400/PT-x-Vac	Optical fiber with protective hose suitable for use in vacuum (3 m, 5 m, 10 m, customer-specific length up to 50 m) ⁵⁾						
C2407-x	with DIN plug and E2000/APC (0.3 m, 2 m, 3 m, 5 m)	⊘	⊘	⊘	⊘	✓ ³⁾	⊘
C2404/PT3-x/UHV	Optical fiber with protective hose in a vacuum-compatible design (0.8 m, 1 m, custom lengths up to 50 m) ^{4) 5)}	✓	⊘	⊘	⊘	⊘	✓
C2404/PT3-xHT/UHV	Optical fiber with protective hose, vacuum-compatible design, and rated up to 200 °C (2 m, custom lengths up to 50 m) ^{4) 5)}	⊘	⊘	⊘	⊘	⊘	✓

¹⁾ Bending radius: static 30 mm, dynamic 40 mm

²⁾ The IFS2404-2 and IFS2404/90-2 sensors come standard with a 2-meter cable. For the IFS2404-2(001) and IFS2404/90-2(001) sensors, use the C2401-x(01) cable. It has a standard length of 3 meters.

³⁾ Only IFS2407/90-0,3

⁴⁾ Bending radius: static 60 mm, dynamic 60 mm

⁵⁾ Cannot be plugged directly into the controller. An FC/FC coupler or C2405 + C2401-x vacuum feedthrough is required

Optical fiber extension for sensors

CE2402 cable with 2x E2000/APC connectors

CE2402-x Extension for optical fiber (3 m, 10 m, 13 m, 30 m, 50 m)

CE2402/PT3-x Optical fiber extension with protective hose for mechanical stress (3 m, 10 m, customer-specific length up to 50 m)

Light source accessories

IFL2422/LED Lamp module for IFC2422 and IFC2466

IFL24x1/LED Lamp module for IFC2421 and IFC2465

Accessories

Mounting adapter

Sensor mounting adapter

MA2402 for 2402 sensors

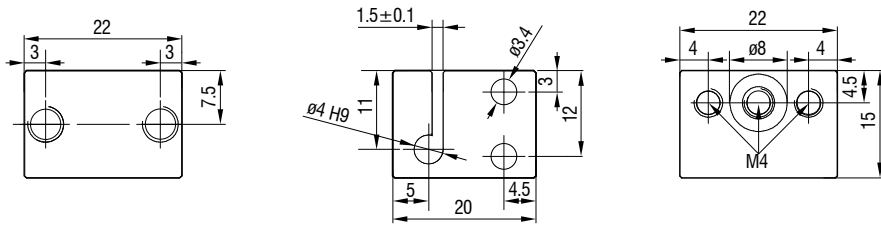

Sensor mounting adapter

MA2403 for IFS2403 sensors

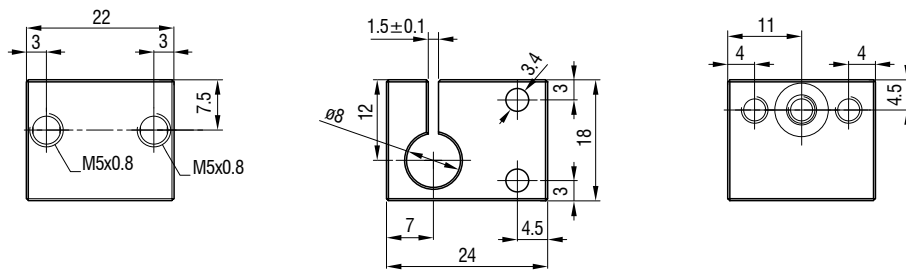

Sensor mounting adapter

MA2404-12 for IFS2404-2 / IFS2404/90-2 / IFS2404-4 / IFS2407-0,1 / IFS2407-0,8 sensors

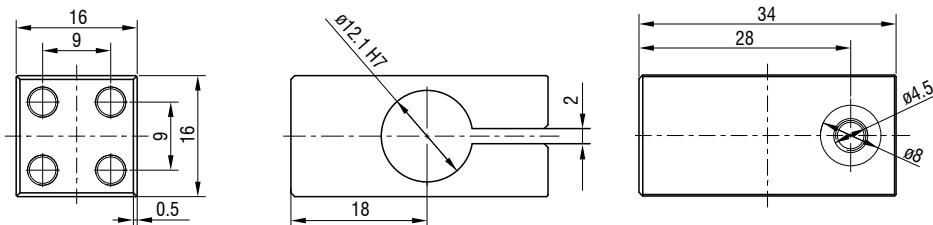

Sensor mounting adapter

MA2400 for IFS2404/IFS2405/IFS2406/IFS2407 sensors (consisting of mounting block and mounting ring)

Mounting block

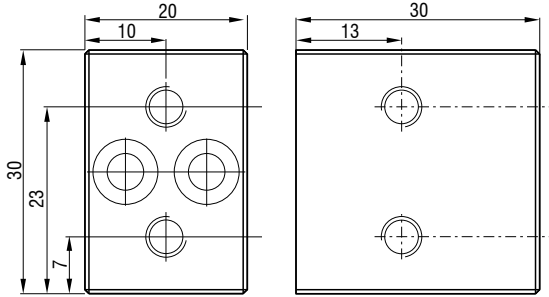

Mounting rings

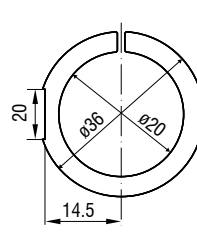

MA 2406-20 for sensors
IFS2406-2,5
IFS2406/90-2.5

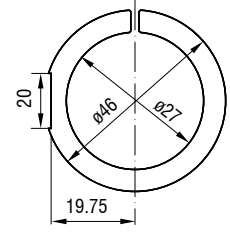

MA 2400-27 for sensors
IFS2404-1 / -3 / -6
IFS2405-0,3 / -1
IFS2406-3 / -10

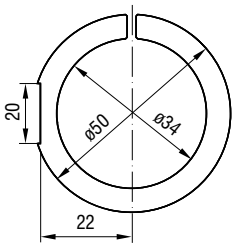

MA 2405-34 for sensors
IFS2405-3
IFS2404-18

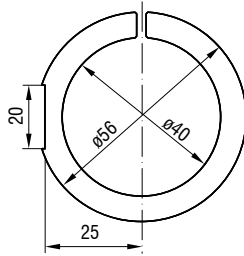

MA 2405-40 for sensor
IFS2405-6

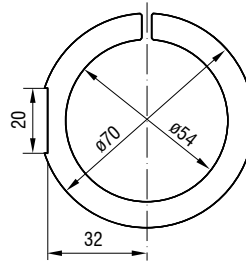

MA 2405-54 for sensors
IFS2405-10
IFS2407-3 / -6

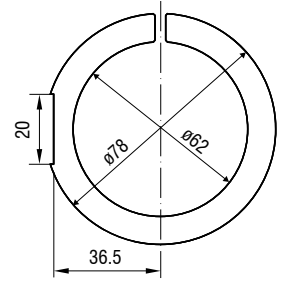

MA 2405-62 for sensors
IFS2405-28 / -30

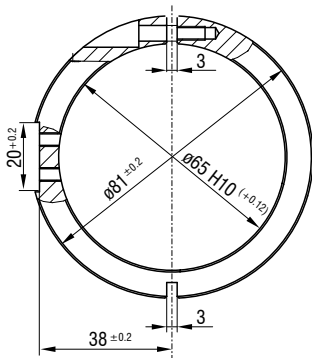

MA 2407-65 for sensor
IFS2407-1,5

Dimensions in mm,
not to scale.



Accessories

Mounting adapter for individual sensors

Manual adjustment mechanism for easy and fast adjustment

Optimal sensor alignment for best possible measurement results

Ideally suitable for machine integration



Particularly for high resolution sensors with a small inclination angle, perpendicular installation is required. The JMA-xx mounting adapter enables fine alignment of the sensor to the target via the simple adjustment mechanism. This makes it easy to compensate for minor mounting deviations or tilted measuring objects.

- 1 JMA-xx
- 1 Sensor holder for smaller diameters (not with JMA-27)
- 1 Hexagon screwdriver for positioning
- Setup guide

Scope of supply

Model	JMA-08	JMA-12	JMA-20	JMA-27
Tilting range	X	±4° (continuously adjustable)		
	Y	±4° (continuously adjustable)		
Shifting range	X	±2 mm (continuously adjustable)		
	Y	±2 mm (continuously adjustable)		
Shock (DIN EN 60068-2-27)	15 g / 6 ms on XYZ axis, 1000 shocks each			
Vibration (DIN EN 60068-2-6)	2 g / 20 ... 500 Hz in XYZ axis, 10 cycles each			
Adjustment mechanism	Screw setting mechanism via M3x0.25 screw with hexagon socket 1.5			
Mounting	2x 2 mounting holes for M4x1			
Sensor mounting	Radial clamping for ø 8 mm	Radial clamping for ø 12 mm	Radial clamping for ø 20 mm	Radial clamping for ø 27 mm
Compatibility	confocalDT: IFS2403 series	confocalDT: IFS2404-2 /-4 IFS2407-0,1 /-0,8	confocalDT: IFS2406-2,5/VAC	confocalDT: IFS2404-1 /-3 /-6 IFS2405-0.3 IFS2405-1 IFS2406-3 IFS2406-10

Application examples:

Alignment

Subsequent correction of the mounting position

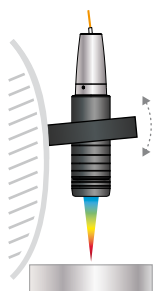

Compensates for incorrect target position

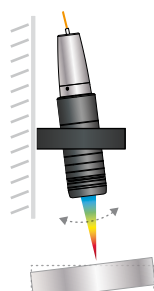

Positioning

Shifting the sensor to target area

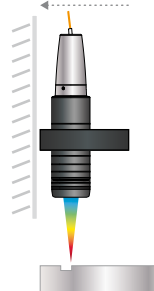

Accessories

Mounting adapter for two-sided thickness measurements

- Optimal alignment of the optical axes enables high precision in two-sided thickness measurements
- Pre-assembled for easy installation and fast commissioning
- Ideally suitable for machine integration

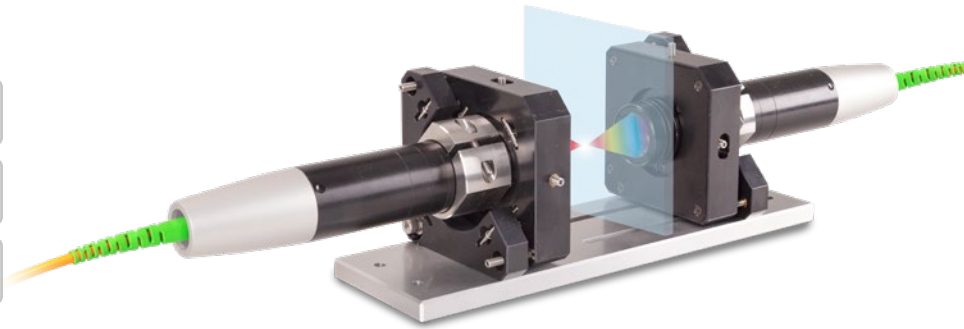

For two-sided thickness measurements, the JMA-Thickness mounting adapter supports the alignment of the measuring points to one another. This means that the measuring points are arranged absolutely congruent to each other so that the sensors are positioned exactly on an optical axis. This prevents measurements at an offset and a reliable measurement result is achieved with the highest possible precision.

When delivered, the two mounting adapters are pre-mounted on a mounting plate and aligned with one another. This simplifies installation and the measuring system can be put into operation more quickly. After installation into the machine, the plate can be removed, if necessary.

Scope of supply

- 2 JMA-xx
- 1 JMP mounting plate
- 1 Hexagon screwdriver 1.5 mm
- 1 Allen wrench 2.5 mm
- 1 Allen wrench 3.0 mm
- 1 Setup guide
- Two optional reducing sleeves (depending on the package and the corresponding sensor)

Model	JMA-Thickness	-08	-12	-20	-27
Shock (DIN EN 60068-2-27)		15 g / 6 ms on XYZ axis, 1000 shocks each			
Vibration (DIN EN 60068-2-6)		2 g / 20 ... 500 Hz in XYZ axis, 10 cycles each			
Adjustment mechanism		Screw setting mechanism via M3x0.25 screw with hexagon socket 1.5			
Sensor mounting		Radial clamping for ø 8 mm	Radial clamping for ø 12 mm	Radial clamping for ø 20 mm	Radial clamping for ø 27 mm
Compatibility		confocalDT: IFS2403 series	confocalDT: IFS2404-2 /-4 IFS2407-0,1 /-0,8	confocalDT: IFS2406-2,5/VAC	confocalDT: IFS2404-1 / -3 / -6 IFS2405-0.3 IFS2405-1 IFS2406-3 IFS2406-10

More precision with two-sided thickness measurements

<p>Without JMA-Thickness: Measurement error with tilted target</p>	<p>Without JMA-Thickness: Incorrect thickness measurement with vibrations</p>	<p>Without JMA-Thickness: Sensors positioned incorrectly – no thickness measurement possible</p>
<p>With JMA-Thickness: Measures exactly at the opposite position</p>	<p>With JMA-Thickness: Sensors are on one optical axis – provides stability even with vibrating objects</p>	<p>With JMA-Thickness: Optimal positioning support – object visible for both sensors</p>

Sensors and Systems from Micro-Epsilon



Sensors and systems for displacement, distance and position



Sensors and measurement devices for non-contact temperature measurement

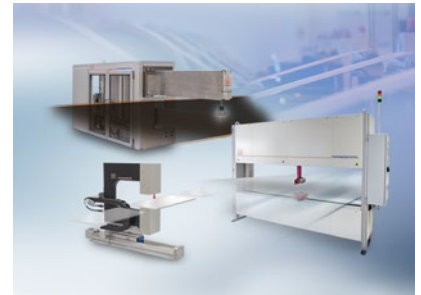

Measuring and inspection systems for metal strips, plastics and rubber



Optical micrometers and fiber optics, measuring and test amplifiers



Color recognition sensors, LED analyzers and inline color spectrometers

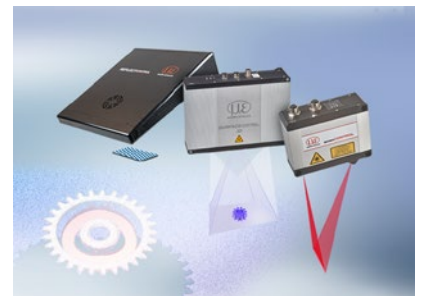

3D measurement technology for dimensional testing and surface inspection